

ITC MALTA

2025

EXHIBITOR OPPORTUNITIES

What is ITC?

The premier networking event for distributors, retailers, traders, resellers, wholesalers, and service providers.

ITC Malta brings together over 800 decision-makers from the mobile phone, IT components, and consumer electronics industries for four days of business. The event is designed around building relationships that drive growth, with a strong buyer focus alongside sellers and service companies that keep the market moving. It's an environment where conversations turn into deals.

At ITC, trust matters. Decisions are made face-to-face, and being the company people know and can find is often what opens the next door. By bringing the industry together in Malta, ITC creates the setting for stronger partnerships and new opportunities.

“Well organised, well attended, and a great place to grow the right relationships.”

Christian McBride,
Associate Director
of Innovation & Strategy



Why exhibit at ITC?

Exhibiting gives your company a fixed presence at the centre of ITC Malta. Unlike visiting, your brand is visible, accessible, and easy for buyers, sellers, and service providers to find. It's the most effective way to meet partners, strengthen relationships, and grow your business.

BE VISIBLE

Your stand is a clear point of contact, making it easy for delegates to find you and start conversations.

MEET DECISION-MAKERS

Talk directly with buyers, sellers, and service providers from over 50 countries who attend ITC ready to trade.

BUILD PARTNERSHIPS

Face-to-face meetings give you the chance to move from introductions to agreements, creating lasting business.

STAY AHEAD

Understand industry trends and the direction of the market so you can plan with confidence.

“Exhibiting makes sure the right people find you, and the right conversations happen.”

Tom Shortland,
Sales Director

blackbell³⁶⁰
DEVICE LIFECYCLE SOLUTIONS



EXHIBITORS OF
**USED
 ELECTRONICS
 & DEVICE LIFECYCLE
 SOLUTIONS**

PORTOMASO SUITE
 HILTON, LEVEL 3

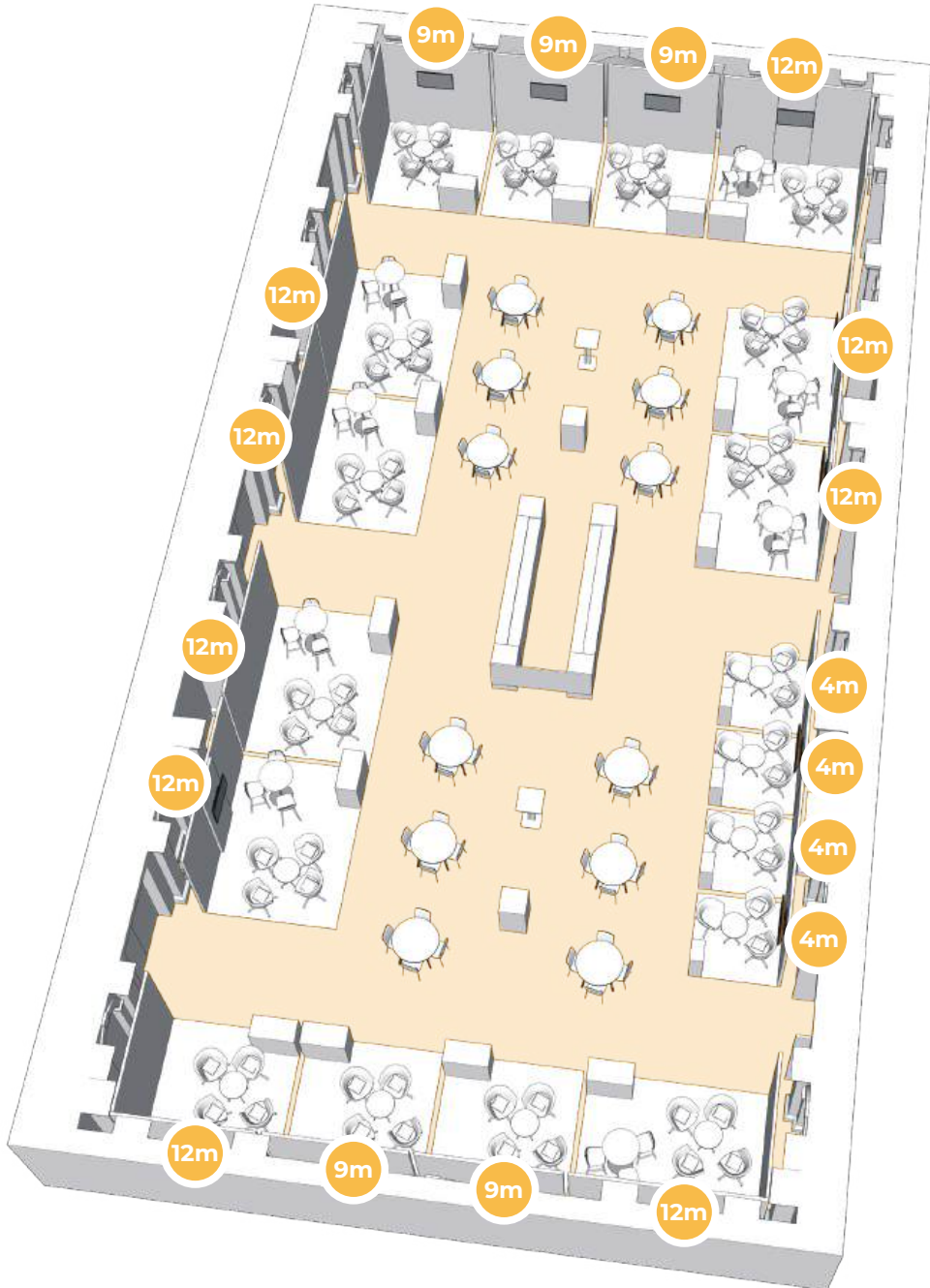

Exhibition Stand Layouts:



12m² Corner Stand



12m² Stand



9m² Corner Stand



9m² Stand



8m² Pod



4m² Pod

EXHIBITORS OF

NEW MOBILES

ACCESSORIES & PARTS

PORTOMASO FOYER
HILTON, LEVEL 3

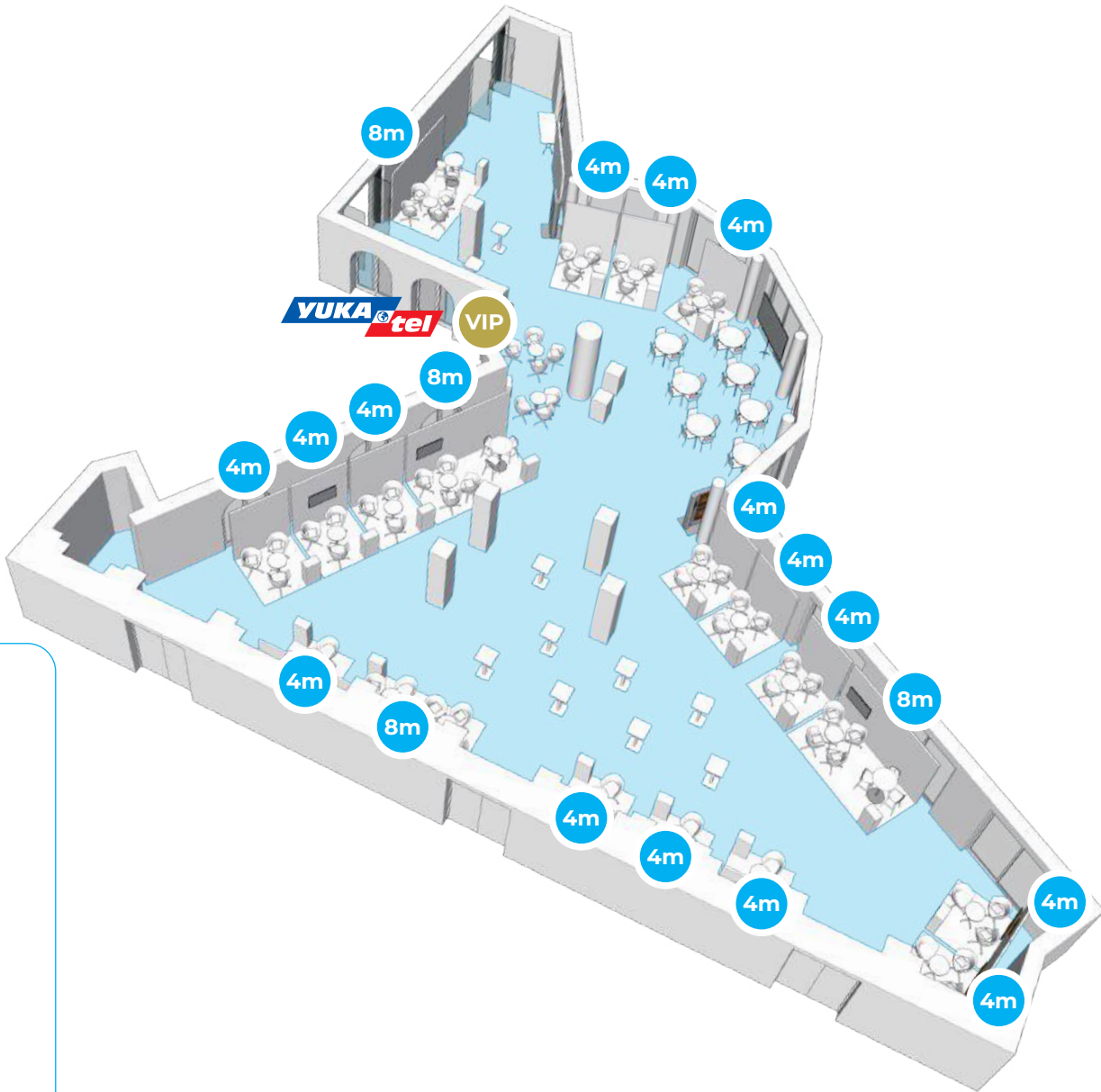

Exhibition Stand Layouts:



12m² Corner Stand



12m² Stand



9m² Corner Stand



9m² Stand



8m² Pod



4m² Pod

EXHIBITORS OF
**NEW
 CE & IT**
 BUSINESS CENTRE
 HILTON, LEVEL 2

Exhibition Stand Layouts:

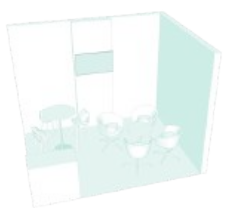

12m² Corner Stand



12m² Stand



9m² Corner Stand

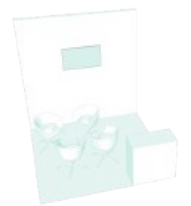

9m² Stand



8m² Pod



4m² Pod

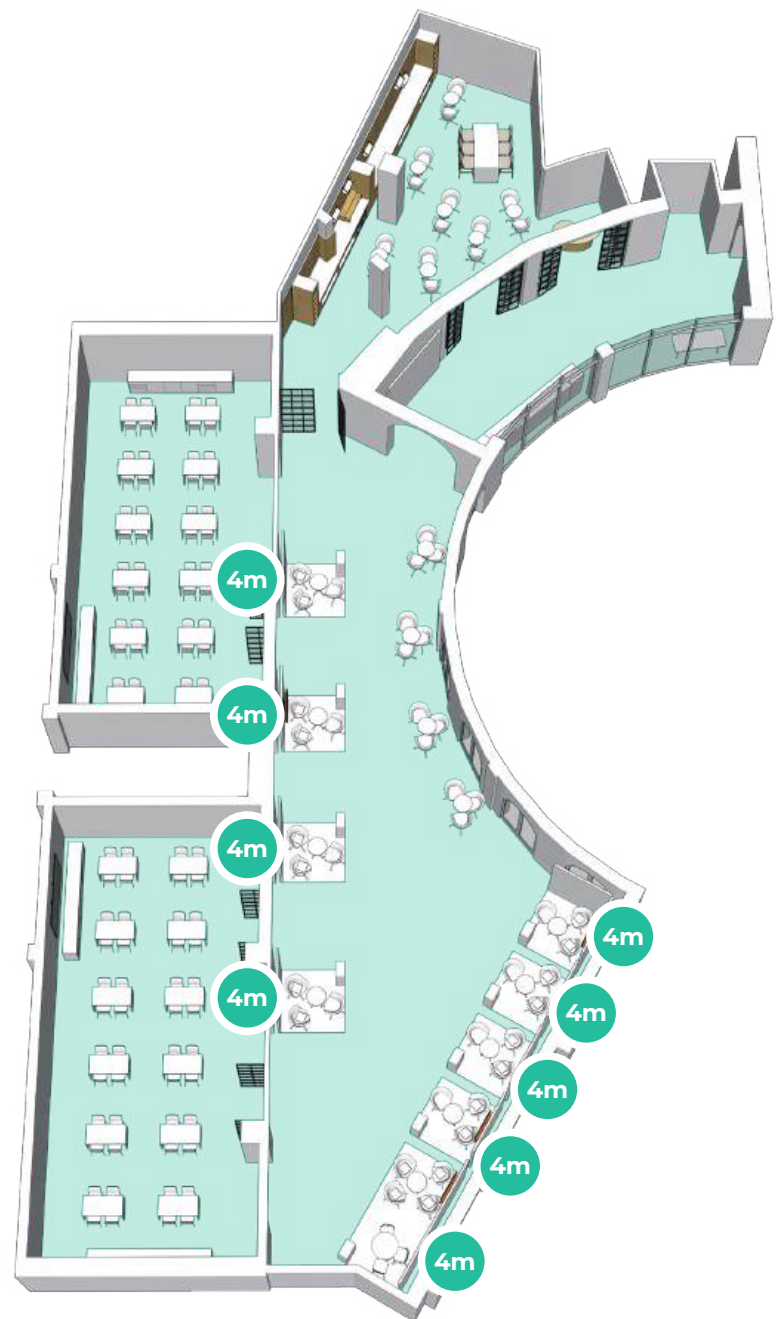

4m²
POD

€6.5K

Stand Configuration :

- ✓ Full-colour printed backdrop
- ✓ Low table with 3 chairs
- ✓ Branded cushions
- ✓ Large screen TV (optional)
- ✓ Branded counter
- ✓ Carpet flooring (various colours)
- ✓ Delegate check-in QR code
- ✓ Professionally installed

Marketing & PR :

- ✓ 1 Delegate ticket
- ✓ Quarter page advert
- ✓ Exhibitor bio in directory
- ✓ Enhanced company profile in directory
- ✓ On-site photography & videography
- ✓ Social media promotion
- ✓ Inclusion in official ITC event footage
- ✓ Personalised 2026 photo book

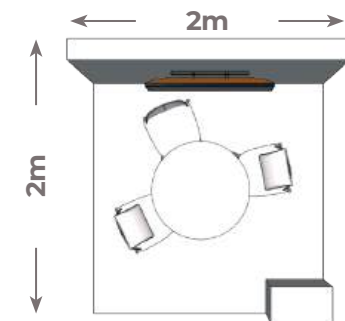
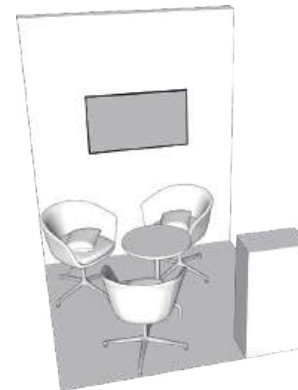



SECURE YOUR EXHIBITION STAND

GET IN TOUCH

To secure your ITC Malta exhibitor package, please get in touch with a member of the ITC team.



Edward Elliot-Square
Sales Director

✉ ed@ipt.cc

☎ +44 1963 251 442

☎ +44 7739 698 928

🌐 itc.events



Headline Sponsor



Book your stand at ITC MALTA 2026

itc.events